

Linear

TANA Nano 2 RS14 Fixture Guide

KKDC

Indoor | Surface | Output up to 976lm/m (297lm/ft)

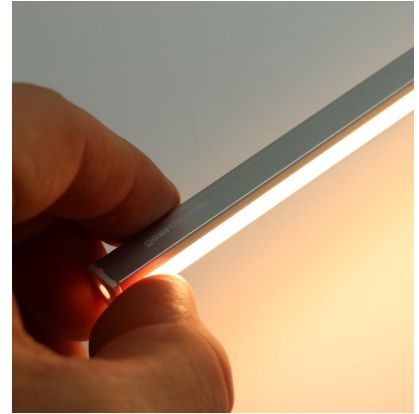

Key applications

- ✓ Architectural detail
- ✓ Cabinet & furniture
- ✓ Direct lighting
- ✓ Display case
- ✓ Interior
- ✓ Retail display
- ✓ Shelving display

Key features

- ✓ Custom lengths
- ✓ Constant Voltage (CV)
- ✓ Diffusion: homogenous
- ✓ Direct view
- ✓ Extensive CCT range
- ✓ IP40 dry area
- ✓ Thin light line

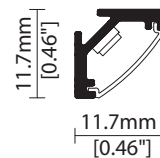

FIXING METHODS



3M Tape fixing

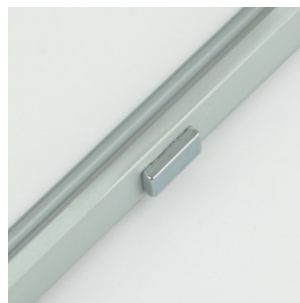

Magnet fixing

Linear

TANA Nano 2 RS14

Specification sheet



Dimensions	H11.7/W11.7/L85-2014mm (H0.46/W0.46/L3.34-79.29in)
PCB Cut-point	35.7mm increment/2000mm max (1.41in increment/78.74in max)
LED Pitch	6mm-168LED/m (0.24in - 51LED/ft)
Chip	s-line k-line
Cover/Optics	Diffused (110°)
CCT	s-line: 1900K/2100K/2300K/2500K/2700K/3000K/3500K/4000K/5000K k-line: 1900K/2100K/2300K/2500K/2700K/3000K/3500K/4000K/5000K
LED binning	s-line: 2-step MacAdam ellipse k-line: 3-step MacAdam ellipse
CRI	≥93
Lifetime	50,000 hours @ 25°C (50,000 hours @ 77°F)
Operating temp	T _a = -25 to 50°C (T _c max = 74.6°C) T _a = -13 to 122°F (T _c max = 166°F)
IP Rating	IP40
Finish	Silver anodised
Mounting	Surface mounting via 3M tape or magnet
Power feed	Hardwire tails or male/female connectors
Control	0-10V/1-10V/DMX/DALI



LED Grading Key

Exclusive Grade

s-line*
2-step CCT range

*KKDC tuned
CCT range

Base Grade

k-line
3-step commercial range
Energy Star CCTs

Power consumption	Supply voltage	Supply current
14W/m (4.27W/ft)	24V DC	0.58A/m (0.18A/ft)

Performance Data (3000K)

	R1	R2	R3	R4	R5	R6	R7	R8	R9	R10	R11	R12	R13	R14
k-line	94	97	98	91	92	95	92	85	67	92	91	75	95	98

Diffused		CRI	R9	Rf	Rg
s-line	976lm/m (297lm/ft) 69.7lm/w	94	69	-	-
k-line	966lm/m (294lm/ft) 69lm/w	93	68	-	-

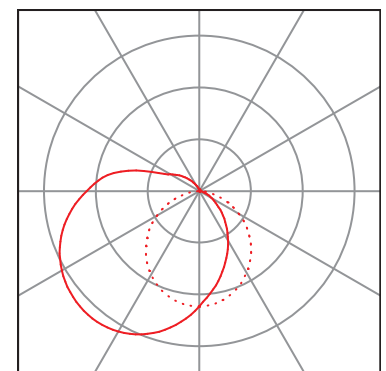
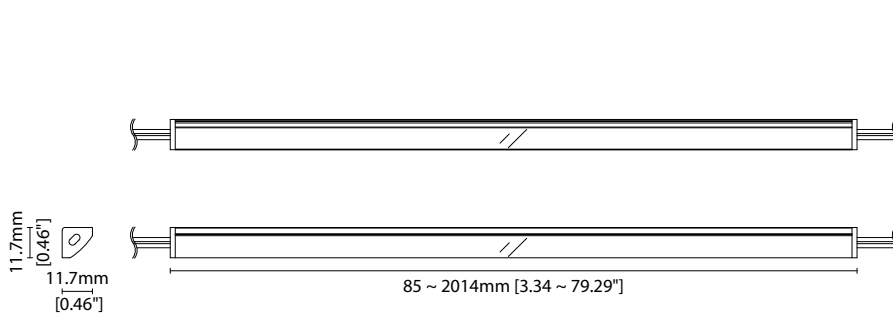

— C0 / C180 cd / 1000 lm C90 / C270

Data derived from independent UKAS / IESNA LM-79-08 accredited testing of production samples.

TANA Nano 2 RS14

Code Table



FIXTURE

Model	Finish	Cover ¹	Grade ²	LED	Colour (CCT)	Length Availability ³	IP	Cable Length	Power Feed ⁴	Fixing ⁵	Input				
TANA Nano 2	TA2 Silver Anodised	SA Diffused	C s k	RS14 RS14	1900K	19	m 85.0-2014mm 35.7mm increments	IP40 40	50mm / 1.97"	0050	Single no sheath tail	S00X	3M Tape fixing	TF	DC 24V
					2100K	21									
					2300K	23									
					2500K	25	i 3.34-79.29in 1.41in increments	(Specify length code OR total run length)	300mm / 11.81"	0300	Double no sheath tail	D00X	Magnet fixing	MF	
					2700K	27									
					3000K	30									
					3500K	35									
					4000K	40									
					5000K	50									

¹ Refer to **Cover Options** on **Options** pages

² Refer to **LED Grading Key** on **Specification sheet** page

³ Refer to **Length Availability List** or enter total run length instead of length code

⁴ Refer to **Power Feed Options** on **Options** pages

⁵ Refer to **Fixing Options** on **Options** pages

Code Example:

TA2	-	SA	-	C	-	s	-	RS14	-	35	-	m	550	-	40	-	1000	-	S00X	-	MF	-	g
TANA Nano 2		Silver Anodised		Diffused		s		RS14		3500K		550mm		IP40		1000mm/39.37"		Single no sheath tail		Magnet fixing		DC 24V	

ACCESSORIES

Connection Accessories

KKCN-01	2 PIN male & female 50mm (1.97in) pair
KKCN-03	2 PIN male & female 300mm (11.81in) pair
KKCN-06	2 PIN 300mm (11.81in) extension lead

PSU/Driver

0-10V/1-10V/DALI/DMX

* Refer to **Driver/PSU Options** page for details or provide requirement and KKDC to offer the suitable option

* Refer to **Power feed** on **Accessories** pages

LED ENGINE VARIANTS (LED STRIP TYPE)

Colour	LED	Lumen/m	Lumen/ft	W/m	W/ft	Spec Doc	Length	Increment
Single CCT	RS07	507	155	7	2.13	TANA Nano 2 RS07	85-2014mm (3.34-79.29in)	35.7mm (1.41in)
	RS14	976	297	14	4.27	TANA Nano 2 RS14	85-2014mm (3.34-79.29in)	35.7mm (1.41in)

* Performance data: s/k-line, Diffused Cover 3000K

COVER OPTIONS

* Options are an integral part of the fixture ordering codes. Please refer to **Code Table** pages.

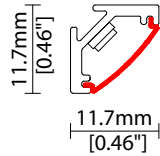

C Diffused Cover
Polycarbonate

FIXING OPTIONS

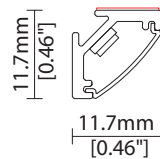
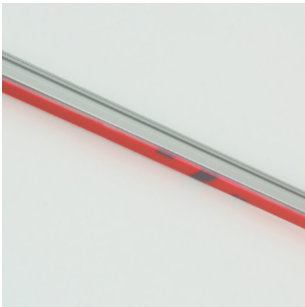

TF Tape fixing

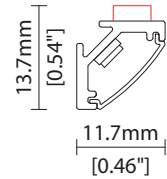

MF Magnet fixing

POWER FEED OPTIONS

0050 S00X 50mm (1.97") Single tail

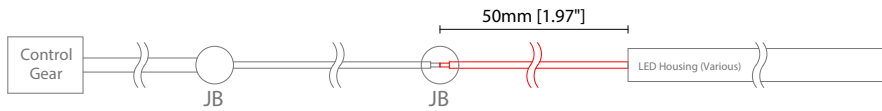

0050 D00X 50mm (1.97") Double tail

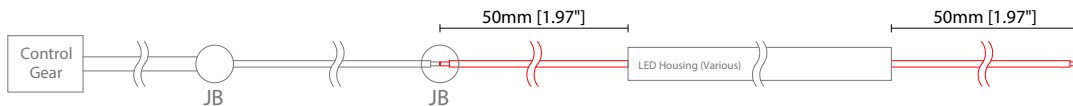

0050 S20X 50mm (1.97") Single IP20 connector

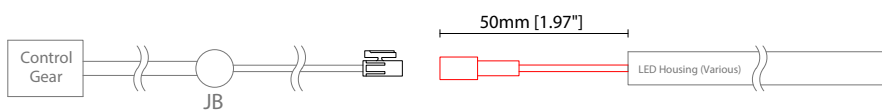

POWER FEED OPTIONS (CONTINUED)

0050 D20X 50mm (1.97") Double IP20 connector

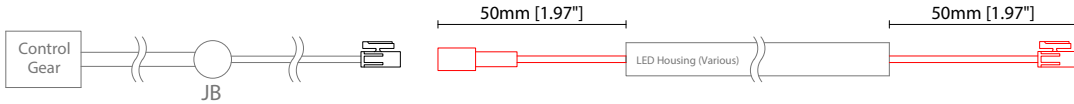

0300 S00X 300mm (11.81") Single tail

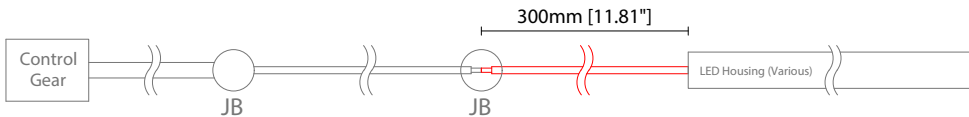

0300 D00X 300mm (11.81") Double tail

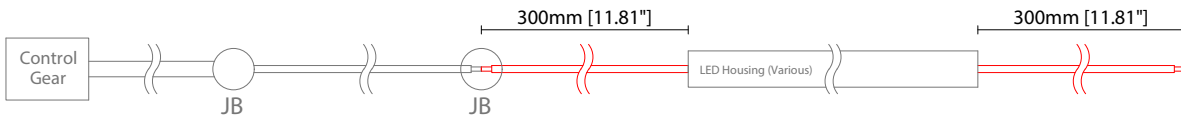

0300 S20X 300mm (11.81") Single IP20 connector

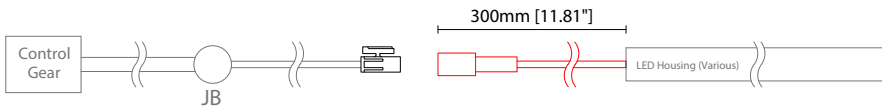

0300 D20X 300mm (11.81") Double IP20 connector

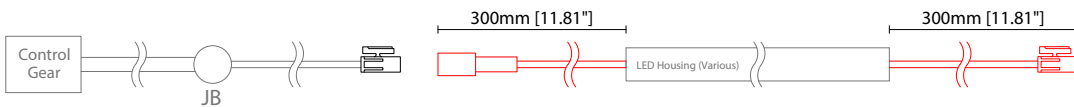

2 Pin Female Connector

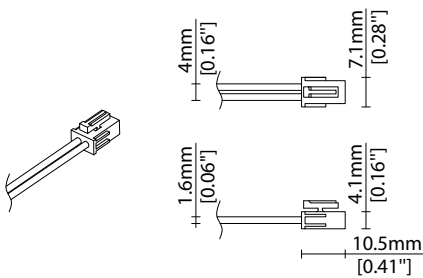

2 Pin Male Connector

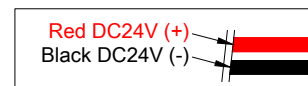
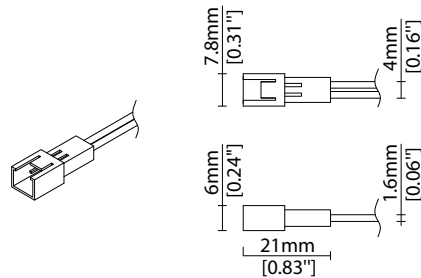

Key

Control Gear Power supply, sub-controllers & control systems

JB Junction box / cable connection

Linear

TANA Nano 2 RS14

Length Availability List



Length Code		Fixture Length ¹		LED Strip ²		End Cap Dimension ³		Wattage (W)	Output (lm)
Metric	Imperial(US)	Metric	Imperial(US)	Metric	Imperial(US)	Metric	Imperial(US)		3000K (Test Data)
m0085	i0003	85mm	3.36in	71mm	2.81in	4mm	0.16in	1.00	53
m0121	i0005	121mm	4.77in	107mm	4.22in	4mm	0.16in	1.50	79
m0157	i0006	157mm	6.18in	143mm	5.62in	4mm	0.16in	2.00	106
m0193	i0008	193mm	7.58in	179mm	7.03in	4mm	0.16in	2.50	132
m0228	i0009	228mm	8.99in	214mm	8.44in	4mm	0.16in	3.00	159
m0264	i0010	264mm	10.39in	250mm	9.84in	4mm	0.16in	3.50	185
m0300	i0012	300mm	11.80in	286mm	11.25in	4mm	0.16in	4.00	212
m0335	i0013	335mm	13.21in	321mm	12.65in	4mm	0.16in	4.50	238
m0371	i0015	371mm	14.61in	357mm	14.06in	4mm	0.16in	5.00	265
m0407	i0016	407mm	16.02in	393mm	15.47in	4mm	0.16in	5.50	291
m0443	i0017	443mm	17.42in	429mm	16.87in	4mm	0.16in	6.00	318
m0478	i0019	478mm	18.83in	464mm	18.28in	4mm	0.16in	6.50	344
m0514	i0020	514mm	20.24in	500mm	19.69in	4mm	0.16in	7.00	371
m0550	i0022	550mm	21.64in	536mm	21.09in	4mm	0.16in	7.50	397
m0585	i0023	585mm	23.05in	571mm	22.50in	4mm	0.16in	8.00	424
m0621	i0024	621mm	24.45in	607mm	23.90in	4mm	0.16in	8.50	450
m0657	i0026	657mm	25.86in	643mm	25.31in	4mm	0.16in	9.00	477
m0693	i0027	693mm	27.27in	679mm	26.72in	4mm	0.16in	9.50	503
m0728	i0029	728mm	28.67in	714mm	28.12in	4mm	0.16in	10.00	530
m0764	i0030	764mm	30.08in	750mm	29.53in	4mm	0.16in	10.50	556
m0800	i0031	800mm	31.48in	786mm	30.93in	4mm	0.16in	11.00	583
m0835	i0033	835mm	32.89in	821mm	32.34in	4mm	0.16in	11.50	609
m0871	i0034	871mm	34.30in	857mm	33.75in	4mm	0.16in	12.00	636
m0907	i0036	907mm	35.70in	893mm	35.15in	4mm	0.16in	12.50	662
m0943	i0037	943mm	37.11in	929mm	36.56in	4mm	0.16in	13.00	689
m0978	i0039	978mm	38.52in	964mm	37.96in	4mm	0.16in	13.50	716
m1014	i0040	1014mm	39.92in	1000mm	39.37in	4mm	0.16in	14.00	742
m1050	i0041	1050mm	41.33in	1036mm	40.78in	4mm	0.16in	14.50	769
m1085	i0043	1085mm	42.73in	1071mm	42.18in	4mm	0.16in	15.00	795
m1121	i0044	1121mm	44.14in	1107mm	43.59in	4mm	0.16in	15.50	822
m1157	i0046	1157mm	45.55in	1143mm	44.99in	4mm	0.16in	16.00	848
m1193	i0047	1193mm	46.95in	1179mm	46.40in	4mm	0.16in	16.50	875
m1228	i0048	1228mm	48.36in	1214mm	47.81in	4mm	0.16in	17.00	901
m1264	i0050	1264mm	49.76in	1250mm	49.21in	4mm	0.16in	17.50	928
m1300	i0051	1300mm	51.17in	1286mm	50.62in	4mm	0.16in	18.00	954
m1335	i0053	1335mm	52.58in	1321mm	52.02in	4mm	0.16in	18.50	981
m1371	i0054	1371mm	53.98in	1357mm	53.43in	4mm	0.16in	19.00	1007
m1407	i0055	1407mm	55.39in	1393mm	54.84in	4mm	0.16in	19.50	1034
m1443	i0057	1443mm	56.79in	1429mm	56.24in	4mm	0.16in	20.00	1060
m1478	i0058	1478mm	58.20in	1464mm	57.65in	4mm	0.16in	20.50	1087
m1514	i0060	1514mm	59.61in	1500mm	59.06in	4mm	0.16in	21.00	1113
m1550	i0061	1550mm	61.01in	1536mm	60.46in	4mm	0.16in	21.50	1140
m1585	i0062	1585mm	62.42in	1571mm	61.87in	4mm	0.16in	22.00	1166

TANA Nano 2 RS14

Length Availability List



Length Code		Fixture Length ¹		LED Strip ²		End Cap Dimension ³		Wattage (W)	Output (lm)
Metric	Imperial(US)	Metric	Imperial(US)	Metric	Imperial(US)	Metric	Imperial(US)		3000K (Test Data)
m1621	i0064	1621mm	63.82in	1607mm	63.27in	4mm	0.16in	22.50	1193
m1657	i0065	1657mm	65.23in	1643mm	64.68in	4mm	0.16in	23.00	1219
m1693	i0067	1693mm	66.64in	1679mm	66.09in	4mm	0.16in	23.50	1246
m1728	i0068	1728mm	68.04in	1714mm	67.49in	4mm	0.16in	24.00	1272
m1764	i0069	1764mm	69.45in	1750mm	68.90in	4mm	0.16in	24.50	1299
m1800	i0071	1800mm	70.85in	1786mm	70.30in	4mm	0.16in	25.00	1325
m1835	i0072	1835mm	72.26in	1821mm	71.71in	4mm	0.16in	25.50	1352
m1871	i0074	1871mm	73.67in	1857mm	73.12in	4mm	0.16in	26.00	1378
m1907	i0075	1907mm	75.07in	1893mm	74.52in	4mm	0.16in	26.50	1405
m1943	i0076	1943mm	76.48in	1929mm	75.93in	4mm	0.16in	27.00	1431
m1978	i0078	1978mm	77.89in	1964mm	77.33in	4mm <td 0.16in	27.50	1458	
m2014	i0079	2014mm	79.29in	2000mm	78.74in	4mm	0.16in	28.00	1484

¹ Actual total overall length of light fixture (LED strip + end caps + void/wire hole)

² Actual length of PCB strip

³ Actual length of 2x end caps

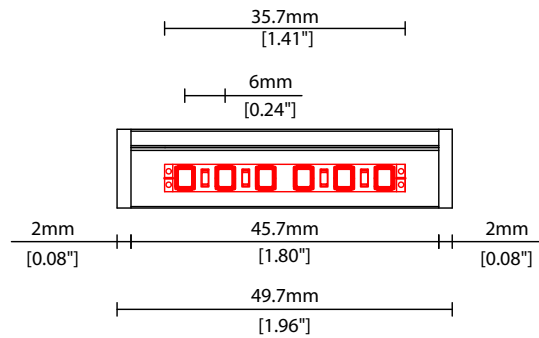

POWER FEED

Note: Accessories are to be ordered separately with corresponding code shown below.

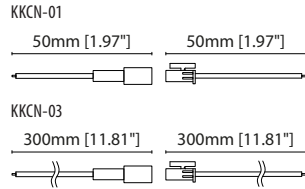
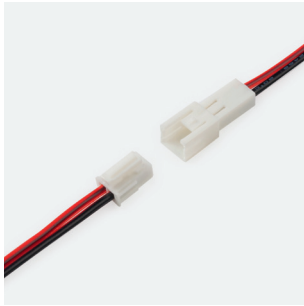

KKCN-01 50mm (1.97in) pair
KKCN-03 300mm (11.81in) pair
 2 PIN male + female connector set

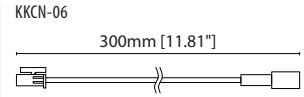

KKCN-06
 2 PIN 300mm (11.81in) extension lead

KKDC CONTROL



IP20
 Plastic housing
 L170/W59/H29mm
 (L6.69/W2.32/H1.14in)

KKDM-06 1-10V
 visDIM dimmable sub-controller
 (4 x 8A max @ 12-36V)



IP20
 Plastic housing
 L170/W53.4/H28mm
 (L6.69/W2.10/H1.10in)

KKSC-05 DMX
 visDIM dimmable sub-controller
 (4 x 5A max @ 12-36V)



IP20
 Plastic housing
 L170/W59/H29mm
 (L6.69/W2.32/H1.14in)

KKDL-02 DALI
 visDIM dimmable sub-controller
 (4 x 8A max @ 12-36V)



IP20
 Plastic housing
 L166/W53.4/H23mm
 (L6.54/W2.10/H0.91in)

KKDL-03 DALI
 visDIM dimmable sub-controller
 (4 x 5A max @ 12-36V)

AVAILABLE PSU OPTIONS

Control Mode	PSU (Order Code)	Input Voltage AC	Output Voltage DC	Rated Output Current	Rated Power	Dim %	IP Rating
Switched	CEN-60-24	90-295V	24V	2.5A	60W	-	IP67
	HLG-60H-24	90-305V	24V	2.5A	60W	-	IP67
	HLG-100H-24	90-305V	24V	4.0A	100W	-	IP67
	HLG-150H-24	90-305V	24V	6.3A	150W	-	IP67
	HLG-240H-24	90-305V	24V	10A	240W	-	IP67
0-10V (1-10V)	PWM-40-24	90-305V	24V	1.67A	40W	100-0.15 (100-10)	IP67
	PWM-60-24	90-305V	24V	2.5A	60W	100-0.15 (100-10)	IP67
	PWM-90-24	90-305V	24V	3.67A	90W	100-0.15 (100-10)	IP67
	PWM-120-24	90-305V	24V	5.0A	120W	100-0.15 (100-10)	IP67
DALI	LIN100A1	120-277V	24V	1A per channel	100W	100-0.1	IP66/IP40
DMX RGB	LIN100A1	120-277V	24V	1.33A per channel	100W	100-0.1	IP66/IP40
DMX RGBW	LIN100A1	120-277A	24V	1A per channel	100W	100-0.1	IP66/IP40

Flicker Free Options - Combination of PSU+ sub-controller

Control Mode	PSU (Order Code)	Sub-controller (Order Code)	Input Voltage AC	Output Voltage DC	Rated Output Current	Rated Power	Dim %	IP Rating PSU/ Sub-controller
0-10V or 1-10V	CEN-60-24	KKDM-06	90-295V	24V	2.5A	60W	100-0.9	IP67/IP20
	HLG-60H-24	KKDM-06	90-295V	24V	2.5A	60W	100-0.9	IP67/IP20
	HLG-100H-24	KKDM-06	90-295V	24V	4.0A	100W	100-0.9	IP67/IP20
	HLG-150H-24	KKDM-06	90-295V	24V	6.3A	150W	100-0.9	IP67/IP20
	HLG-240H-24	KKDM-06	90-295V	24V	10.0A	240W	100-0.9	IP67/IP20
DALI	CEN-60-24	KKDL-02/03	90-295V	24V	2.5A	60W	100-0.1	IP67/IP20
	HLG-60H-24	KKDL-02/03	90-305V	24V	2.5A	60W	100-0.1	IP67/IP20
	HLG-100H-24	KKDL-02/03	90-305V	24V	4.0A	100W	100-0.1	IP67/IP20
	HLG-150H-24	KKDL-02/03	90-305V	24V	6.3A	150W	100-0.1	IP67/IP20
	HLG-240H-24	KKDL-02/03	90-305V	24V	10.0A	240W	100-0.1	IP67/IP20
DMX RGB	CEN-60-24	KKSC-05	90-295V	24V	2.5A	60W	100-0.9	IP67/IP20
	HLG-60H-24	KKSC-05	90-305V	24V	2.5A	60W	100-0.9	IP67/IP20
	HLG-100H-24	KKSC-05	90-305V	24V	4A	100W	100-0.9	IP67/IP20
	HLG-150H-24	KKSC-05	90-305V	24V	6.3A	150W	100-0.9	IP67/IP20
	HLG-240H-24	KKSC-05	90-305V	24V	10.0A	240W	100-0.9	IP67/IP20

¹ The items shown above cover the most frequently used specification but does not exhaust the possible options

² PSU and/or driver can be chosen from the table, or KKDC may recommend the best option upon receipt of the controls requirement and installation environment

³ Electrical shop drawing will include detailed information of PSU and relevant control drivers

⁴ Cut sheets are available on the controls section of www.kkdc.lighting or upon request